

NOTES: (SEE INSTALLATION & OPERATION MANUAL LMENIM 3306 FOR DETAILS)  
CIRCUIT SHOWN WITH VALVE IN FULLY CLOSED POSITION AND WITH POWER OFF.

- REMOTE INPUTS**  
SIGNAL THRESHOLD - MINIMUM "ON" 19.2V AC/DC  
MAXIMUM "OFF" 5.0V AC/DC  
MAX LOAD - 10 mA / 110V AC  
2 mA / 24V DC  
REQUIRED CONTROL SIGNAL DURATION = 350ms MIN.  
INPUTS 0,1,2 ARE FIELD CONFIGURABLE FOR CLOSE/OPEN INHIBIT, USER INPUT OR ESD. IN ADDITION, INPUT 2 MAY BE CONFIGURED FOR CSE REMOTE SELECTION INDICATION.  
DEFAULT INPUT CONFIGURATION:  
INPUT 0 - ESD,  
INPUT 1 - OPEN INHIBIT,  
INPUT 2 - CLOSE INHIBIT.

- RELAY BOARDS**  
SET JUMPER J1 TO POSITION 3-4 ON THE RELAY BOARD. CONNECT 22-PIN CONNECTOR WITH YELLOW WIRES TO J3 ON THE RELAY BOARD.

- THREE PHASE SUPPLY**  
230 VAC AND BELOW UNITS DRAW POWER ON ALL THREE PHASES. 380 VAC AND ABOVE UNITS DRAW POWER ON L1 AND L2. L3 IS A PARKING TERMINAL FOR INCOMING POWER WHEN MULTIPLE QX UNITS ARE ON THE SAME BRANCH FEEDER, ALTERNATE THE UNUSED PHASE INTO L1 AND L2.

- REMOTE INPUT JUMPERS**  
JUMPERS CAN BE USER WIRED TO CONNECT DIG COMMONS #1, 2 & 3 (AS NEEDED). THE 3 REMOTE WIRING GROUPS ARE ELECTRICALLY ISOLATED, INTERNALLY. ONLY A SINGLE POWER SOURCE MAY BE USED TO POWER ANY ONE GROUP BUT DIFFERENT SOURCES MAY POWER DIFFERENT GROUPS. IF DIFFERENT SOURCES ARE USED, ENSURE THAT THE POLARITIES ARE CORRECT.
- DEFAULT [S] SETTINGS**  
THE DEFAULT OPERATING CONFIGURATION FOR THE "S" OUTPUTS ARE SHOWN IN THE TABLE BELOW. THE CONTACT STATES SHOWN IN THE SCHEMATIC REPRESENT A FULLY CLOSED VALVE. SEE OPERATION MANUAL FOR ALTERNATE CONFIGURATIONS.

OUTPUT SWITCH	VALVE POSITION		FUNCTION
	FULL CLOSE	FULL OPEN	
S1a	—	—	CLOSE LIMIT
S1b	—	—	
S2a	—	—	OPEN LIMIT
S2b	—	—	

— OPEN CONTACT  
█ CLOSED CONTACT

- MAXIMUM EXTERNAL LOAD**  
TERMINALS 21 AND 22 (24 VDC)  
- 5W MAX. EXT. LOAD
- CONTACT RATINGS**  
S1, S2- 0.5 AMP @ 125 VAC, 2 AMPS @ 30 VDC (RESISTIVE)  
MONITOR- 0.5 AMP @ 125 VAC, 2 AMPS @ 30 VDC (RESISTIVE)  
R5-R8- 5 AMPS @ 250 VAC OR 30 VDC (RESISTIVE)

(-) NEGATIVE COMMON

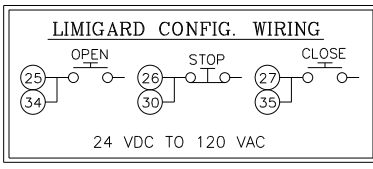
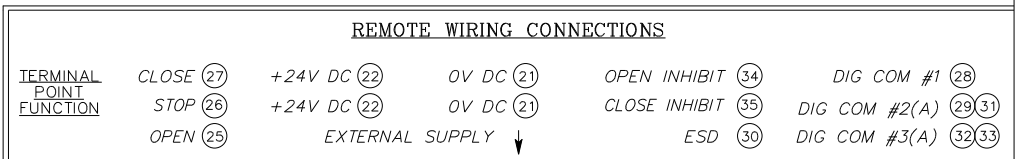
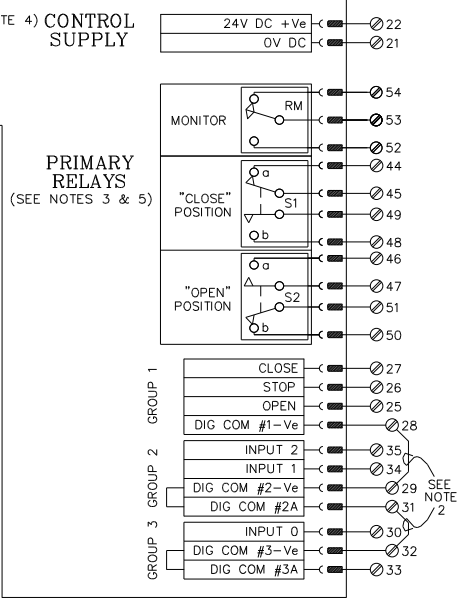
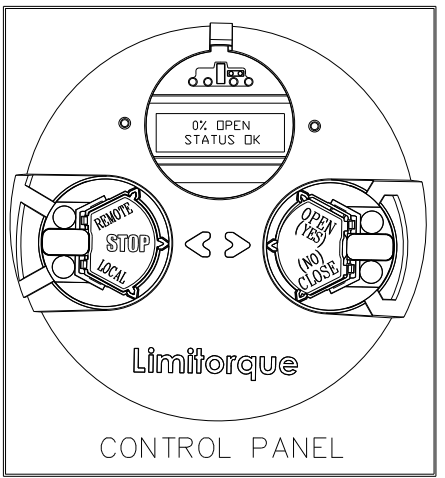
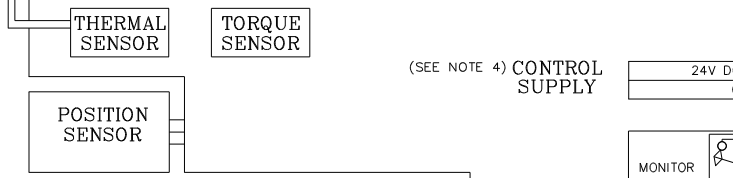
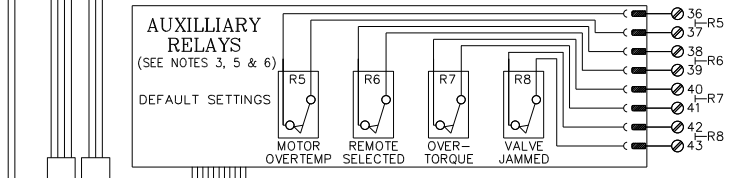
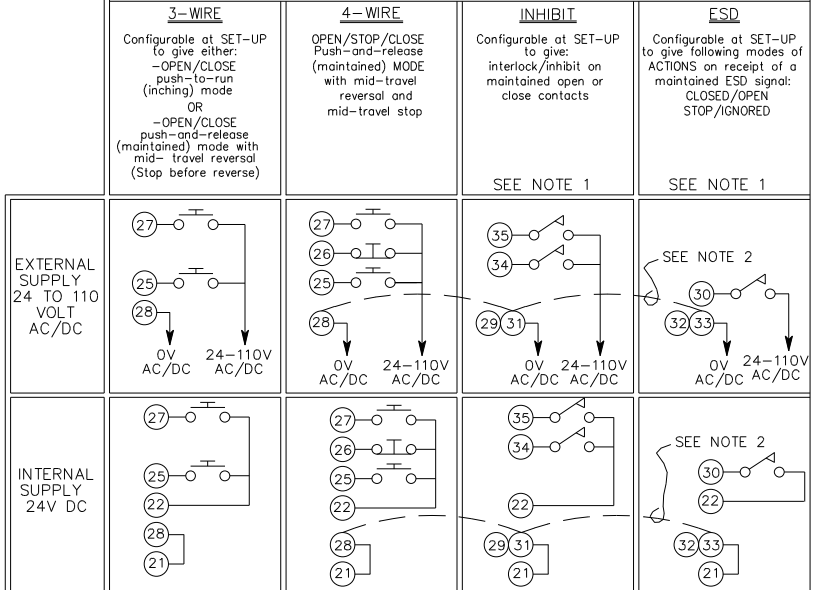

DRAWN	DATE	FLOWERVE Limitorque Actuation Systems 5114 WOODALL ROAD, LYNNBURG, VIRGINIA 24066-1318	
RAC	11/10/10	TITLE	QX WIRING DIAGRAM
CHECKED	DATE	Standard	No CS
ZKC	11/12/10	No Analog	
APPROVED	DATE	3 Phase High Volt	
MAD	11/15/10	OB, OS w/ opt (4) 5A. (1) 2A monitor relay	
UNIT TYPE	QX	DWG NO	WD-QX-220000-00000
REV	000	REVOOH	SHEET 1 OF 1