

NOTES: (SEE INSTALLATION & OPERATION MANUAL LMENIM 3306 FOR DETAILS)
CIRCUIT SHOWN WITH VALVE IN FULLY CLOSED POSITION AND WITH POWER OFF.

- REMOTE INPUTS**
SIGNAL THRESHOLD - MINIMUM "ON" 19.2V AC/DC
MAXIMUM "OFF" 5.0V AC/DC
MAX LOAD - 10 mA / 110V AC
2 mA / 24V DC
REQUIRED CONTROL SIGNAL DURATION = 350ms MIN.
INPUTS 0,1,2 ARE FIELD CONFIGURABLE FOR CLOSE/OPEN INHIBIT, USER INPUT OR ESD. IN ADDITION, INPUT 2 MAY BE CONFIGURED FOR CSE REMOTE SELECTION INDICATION.
DEFAULT INPUT CONFIGURATION:
INPUT 0 - ESD,
INPUT 1 - OPEN INHIBIT,
INPUT 2 - CLOSE INHIBIT.

- RELAY BOARDS**
SET JUMPER J1 TO POSITION 3-4 ON THE RELAY BOARD. CONNECT 22-PIN CONNECTOR WITH YELLOW WIRES TO J3 ON THE RELAY BOARD.

- INPUT LOADS**
IMPEDANCE = 150 OHMS
CAPACITANCE = 0.1 uF 30%
STANDARD SIGNAL: 4-20 mA

- THREE PHASE SUPPLY**
230 VAC AND BELOW UNITS DRAW POWER ON ALL THREE PHASES. 380 VAC AND ABOVE UNITS DRAW POWER ON L1 AND L2. L3 IS A PARKING TERMINAL FOR INCOMING POWER WHEN MULTIPLE QX UNITS ARE ON THE SAME BRANCH FEEDER, ALTERNATE THE UNUSED PHASE INTO L1 AND L2.

- APT OR ATT EXTERNAL LOAD**
4-20 mA OUTPUT SIGNAL - 600 OHMS MAX.
0-10 VDC OUTPUT SIGNAL - 1000 OHMS MAX.
SET JUMPERS JP1 AND JP2 TO POSITION 1-2 ON ANALOG BOARD.
THE 3-PIN CONNECTOR WITH BLUE WIRES SHOULD BE CONNECTED TO J3 ON THE ANALOG BOARD.

- REMOTE INPUT JUMPERS**
JUMPERS CAN BE USER WIRED TO CONNECT DIG COMMONS #1, 2 & 3 (AS NEEDED). THE 3 REMOTE WIRING GROUPS ARE ELECTRICALLY ISOLATED, INTERNALLY. ONLY A SINGLE POWER SOURCE MAY BE USED TO POWER ANY ONE GROUP BUT DIFFERENT SOURCES MAY POWER DIFFERENT GROUPS. IF DIFFERENT SOURCES ARE USED, ENSURE THAT THE POLARITIES ARE CORRECT.
- DEFAULT [S] SETTINGS**
THE DEFAULT OPERATING CONFIGURATION FOR THE "S" OUTPUTS ARE SHOWN IN THE TABLE BELOW. THE CONTACT STATES SHOWN IN THE SCHEMATIC REPRESENT A FULLY CLOSED VALVE. SEE OPERATION MANUAL FOR ALTERNATE CONFIGURATIONS.

OUTPUT SWITCH CONTACT DEVELOPMENT			
OUTPUT SWITCH	VALVE POSITION		FUNCTION
	FULL CLOSE	FULL OPEN	
S1a	█	---	CLOSE LIMIT
S1b	---	█	
S2a	---	█	
S2b	█	---	OPEN LIMIT

--- OPEN CONTACT
█ CLOSED CONTACT

- MAXIMUM EXTERNAL LOAD**
TERMINALS 21 AND 22 (24 VDC)
- 5W MAX. EXT. LOAD
- CONTACT RATINGS**
S1, S2- 0.5 AMP @ 125 VAC, 2 AMPS @ 30 VDC (RESISTIVE)
MONITOR- 0.5 AMP @ 125 VAC, 2 AMPS @ 30 VDC (RESISTIVE)
R5-R8- 5 AMPS @ 250 VAC OR 30 VDC (RESISTIVE)

- COMMAND PRIORITY**
PLEASE SEE INSTALLATION AND OPERATION MANUAL LMENIM 3306 FOR NETWORK COMMAND PRIORITIES.

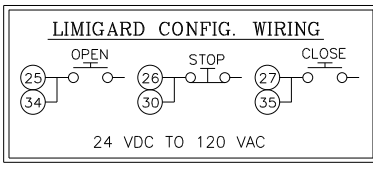
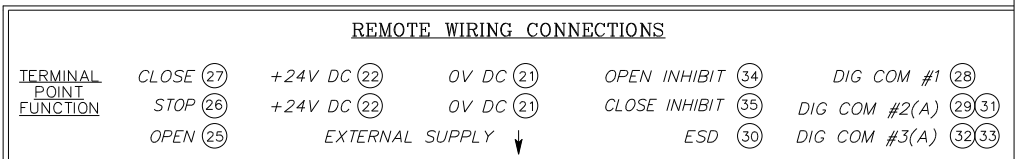
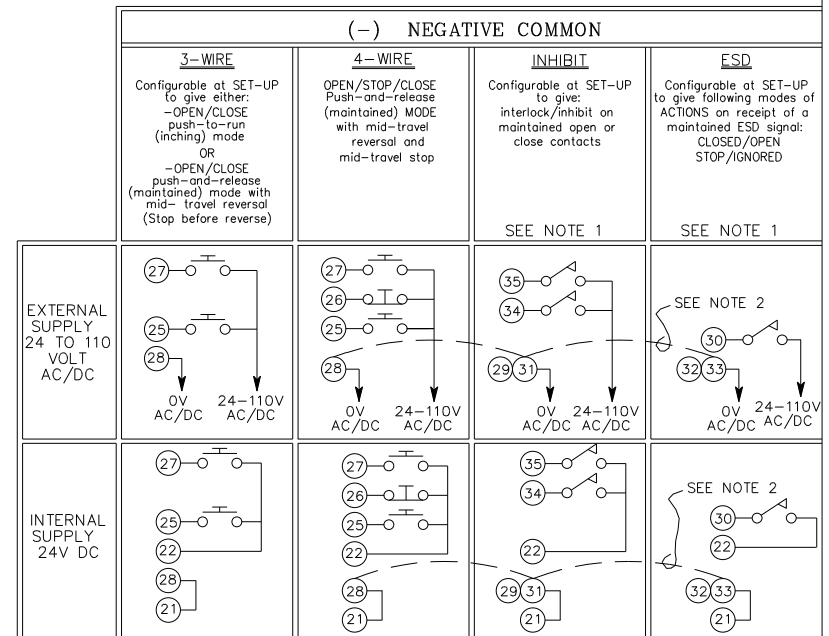
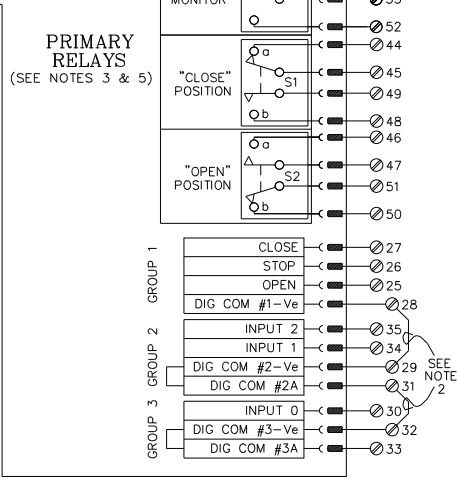
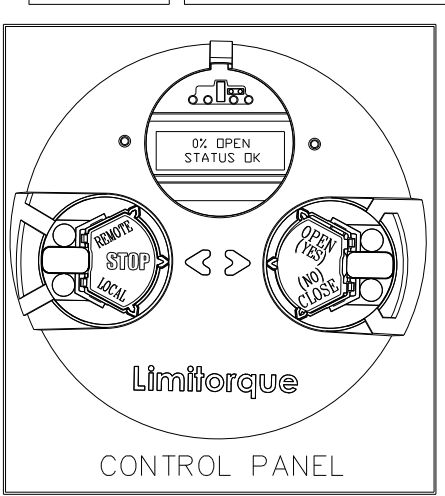
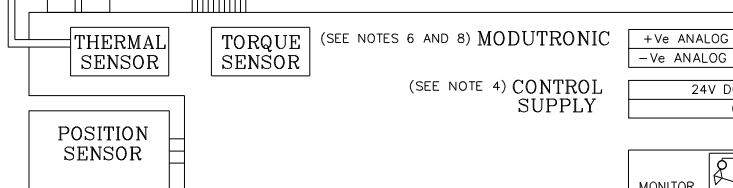
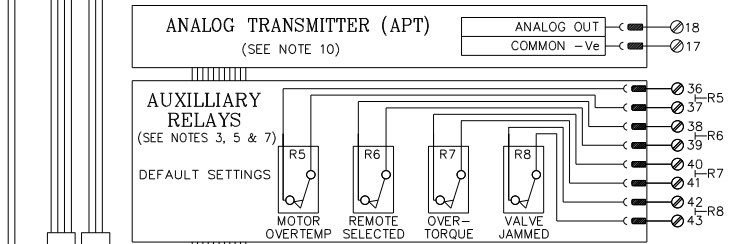

DRAWN	DATE	Limitorque Actuation Systems 5114 WOODALL ROAD, LYNCHBURG, VIRGINIA 24506-1318
RAC	11/10/10	
CHECKED	DATE	TITLE
ZKC	11/12/10	QX WIRING DIAGRAM
APPROVED	DATE	No CS
MAD	11/15/10	Modutronic
		APT (Analog Position Transmitter)
		3 Phase High Volt
		OB, OS w/ opt (4) 5A. (1) 2A monitor relay
		3Wire_4Wire
UNIT TYPE	QX	DWG NO
		WD-QX-220110-00000
REV	00H	SHEET
		1 OF 1