

NOTES: (SEE INSTALLATION & OPERATION MANUAL LMENIM 3306 FOR DETAILS)
CIRCUIT SHOWN WITH VALVE IN FULLY CLOSED POSITION AND WITH POWER OFF.

- REMOTE INPUTS**
SIGNAL THRESHOLD - MINIMUM "ON" 19.2V AC/DC
MAXIMUM "OFF" 5.0V AC/DC
MAX LOAD - 10 mA / 110V AC
2 mA / 24V DC
REQUIRED CONTROL SIGNAL DURATION = 350ms MIN.
INPUTS 0,1,2 ARE FIELD CONFIGURABLE FOR CLOSE/OPEN INHIBIT, USER INPUT OR ESD. IN ADDITION, INPUT 2 MAY BE CONFIGURED FOR CSE REMOTE SELECTION INDICATION.
DEFAULT INPUT CONFIGURATION:
INPUT 0 - ESD,
INPUT 1 - OPEN INHIBIT,
INPUT 2 - CLOSE INHIBIT.

- REMOTE INPUT JUMPERS**
JUMPERS CAN BE USER WIRED TO CONNECT DIG COMMONS #1, 2 & 3 (AS NEEDED). THE 3 REMOTE WIRING GROUPS ARE ELECTRICALLY ISOLATED, INTERNALLY. ONLY A SINGLE POWER SOURCE MAY BE USED TO POWER ANY ONE GROUP BUT DIFFERENT SOURCES MAY POWER DIFFERENT GROUPS. IF DIFFERENT SOURCES ARE USED, ENSURE THAT THE POLARITIES ARE CORRECT.

- DEFAULT [S] SETTINGS**
THE DEFAULT OPERATING CONFIGURATION FOR THE "S" OUTPUTS ARE SHOWN IN THE TABLE BELOW. THE CONTACT STATES SHOWN IN THE SCHEMATIC REPRESENT A FULLY CLOSED VALVE. SEE OPERATION MANUAL FOR ALTERNATE CONFIGURATIONS.

OUTPUT SWITCH	VALVE POSITION		FUNCTION
	FULL CLOSE	FULL OPEN	
S1a	█	---	CLOSE LIMIT
S1b	---	█	
S2a	---	█	
S2b	█	---	OPEN LIMIT

--- OPEN CONTACT
█ CLOSED CONTACT

- MAXIMUM EXTERNAL LOAD**
TERMINALS 21 AND 22 (24 VDC)
- 5W MAX. EXT. LOAD
- CONTACT RATINGS**
S1, S2- 0.5 AMP @ 125 VAC, 2 AMPS @ 30 VDC (RESISTIVE)
MONITOR- 0.5 AMP @ 125 VAC, 2 AMPS @ 30 VDC (RESISTIVE)
R5-R8- 5 AMPS @ 250 VAC OR 30 VDC (RESISTIVE)

- RELAY BOARDS**
SET JUMPER J1 TO POSITION 3-4 ON THE RELAY BOARD. CONNECT 22-PIN CONNECTOR WITH YELLOW WIRES TO J3 ON THE RELAY BOARD.
- APT OR ATT EXTERNAL LOAD**
4-20 mA OUTPUT SIGNAL - 600 OHMS MAX.
0-10 VDC OUTPUT SIGNAL - 1000 OHMS MAX.
SET JUMPERS JP1 AND JP2 TO POSITION 1-2 ON ANALOG BOARD.
THE 3-PIN CONNECTOR WITH BLUE WIRES SHOULD BE CONNECTED TO J3 ON THE ANALOG BOARD.

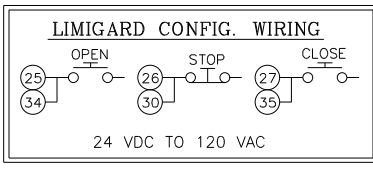
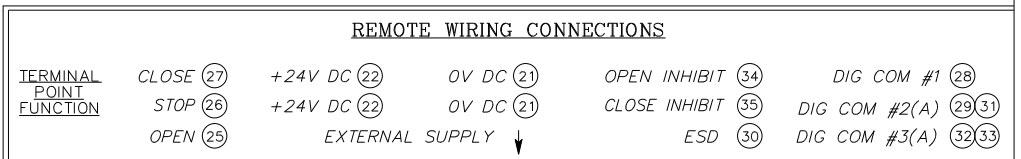
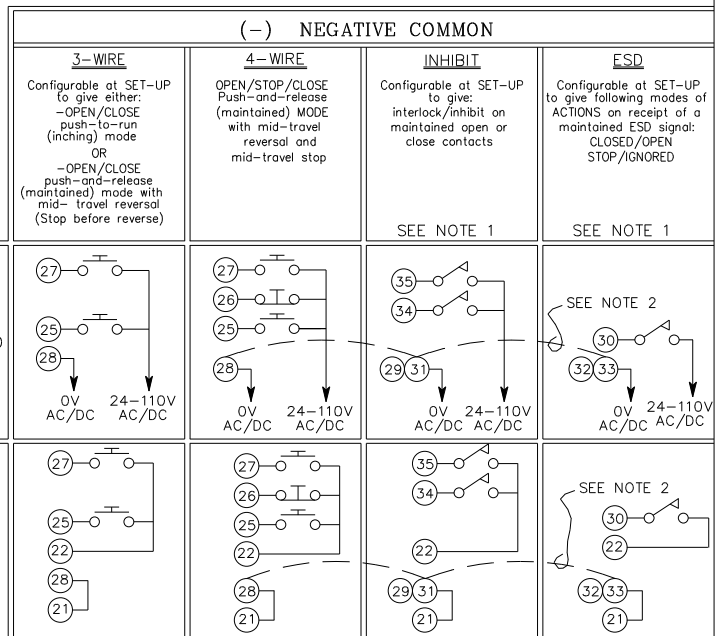
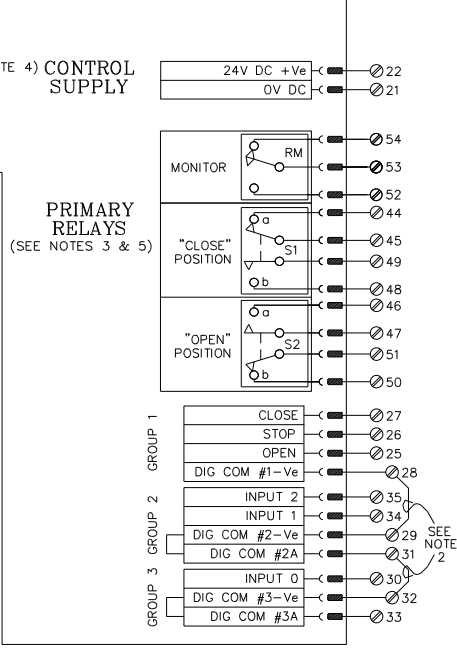
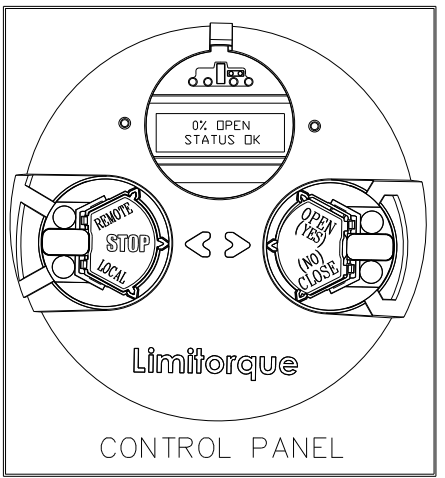
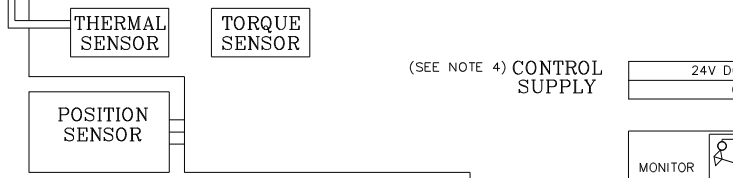
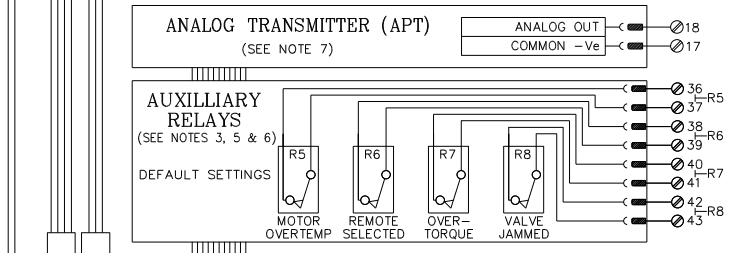

DRAWN	DATE	FLOWERVE Limitorque Actuation Systems 5114 WOODALL ROAD, LYNCHBURG, VIRGINIA 24506-1318	
RAC	11/10/10	TITLE	QX WIRING DIAGRAM
CHECKED	DATE	Standard	No CS
ZKC	11/12/10	APT (Analog Position Transmitter)	Single Phase Low Volt
APPROVED	DATE	OB, OS w/ opt (4) 5A. (1) 2A monitor relay	3Wire_4Wire
MAD	11/15/10	UNIT TYPE	QX
		DWG NO	WD-QX-020010-00000
		REV	000
		SHEET	1 OF 1