

NOTES: (SEE INSTALLATION & OPERATION MANUAL LMENIM 2306 FOR DETAILS)
CIRCUIT SHOWN WITH VALVE IN FULLY CLOSED POSITION AND WITH POWER OFF.

- REMOTE INPUTS**
SIGNAL THRESHOLD - MINIMUM "ON" 19.2V AC/DC
MAXIMUM "OFF" 5.0V AC/DC
MAX LOAD - 10 mA / 110V AC
2 mA / 24V DC
REQUIRED CONTROL SIGNAL DURATION = 350ms MIN.
INPUTS 0,1,2 ARE FIELD CONFIGURABLE FOR CLOSE/OPEN INHIBIT, USER INPUT, OR ESD.
INPUT 1 MAY ALSO BE CONFIGURED FOR PARTIAL STROKE TEST.
INPUT 2 MAY ALSO BE CONFIGURED FOR CSE REMOTE SELECTION INDICATION.
DEFAULT INPUT CONFIGURATION
INPUT 0 - ESD,
INPUT 1 - OPEN INHIBIT,
INPUT 2 - CLOSE INHIBIT.

- INPUT LOADS**
IMPEDANCE = 150 OHMS
CAPACITANCE = 0.1 uF 30%
STANDARD SIGNAL: 4-20 mA
- APT OR ATT EXTERNAL LOAD**
4-20 mA OUTPUT SIGNAL - 600 OHMS MAX.
0-10 VDC OUTPUT SIGNAL - 1000 OHMS MAX.
SET JUMPERS JP1 AND JP2 TO POSITION 1-2 ON ANALOG BOARD.
THE 3-PIN CONNECTOR WITH BLUE WIRES SHOULD BE CONNECTED TO J3 ON THE ANALOG BOARD.

- REMOTE INPUT JUMPERS**
JUMPERS CAN BE USER WIRED TO CONNECT DIG COMMONS #1, 2 & 3 (AS NEEDED). THE 3 REMOTE WIRING GROUPS ARE ELECTRICALLY ISOLATED, INTERNALLY. ONLY A SINGLE POWER SOURCE MAY BE USED TO POWER ANY ONE GROUP BUT DIFFERENT SOURCES MAY POWER DIFFERENT GROUPS. IF DIFFERENT SOURCES ARE USED, ENSURE THAT THE POLARITIES ARE CORRECT.

- DEFAULT [S] SETTINGS**
THE DEFAULT OPERATING CONFIGURATION FOR THE "S" OUTPUTS ARE SHOWN IN THE TABLE BELOW.
THE CONTACT STATES SHOWN IN THE SCHEMATIC REPRESENT A FULLY CLOSED VALVE.
SEE OPERATION MANUAL FOR ALTERNATE CONFIGURATIONS.

OUTPUT SWITCH	VALVE POSITION		FUNCTION
	FULL CLOSE	FULL OPEN	
S1a	—	—	CLOSE LIMIT
S1b	—	—	
S2a	—	—	OPEN LIMIT
S2b	—	—	

— OPEN CONTACT
█ CLOSED CONTACT

- MAXIMUM EXTERNAL LOAD**
TERMINALS 21 AND 22 (24 VDC)
- 5W MAX. EXT. LOAD
- CONTACT RATINGS**
S1, S2- 0.5 AMP @ 125 VAC, 2 AMPS @ 30 VDC (RESISTIVE).
MONITOR- 0.5 AMP @ 125 VAC, 2 AMPS @ 30 VDC (RESISTIVE)
- COMMAND PRIORITY**
PLEASE SEE INSTALLATION AND OPERATION MANUAL LMENIM 2306 FOR NETWORK COMMAND PRIORITIES.
- FUSES**
FS1 (PRIMARY) } 600V AC, 1A, 100KA INT RATING,
FAST ACTING 10.3 x 38.1mm TUBE,
UL LISTED, CSA CERTIFIED
FS2 (PRIMARY) }

TYPE	TAPS	APPL. VOLTAGES
1	106V	110V
	115V	115V, 120V
	200V	208V
	212V	220V
2	226V	226V, 230V, 240V
	366V	380V
	392V	400V, 415V
	450V	440V, 460V, 480V
	212V	220V
3	505V	525V
	530V	550V
	572V	575V, 600V

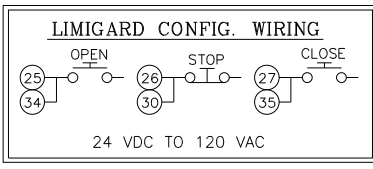
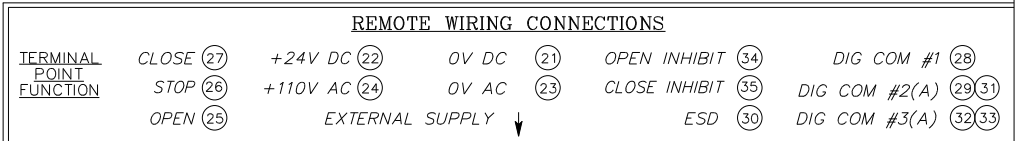
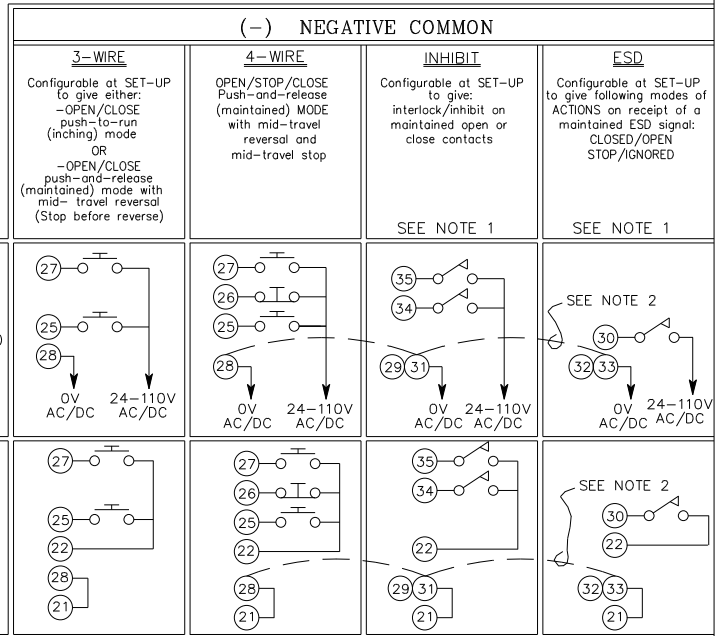
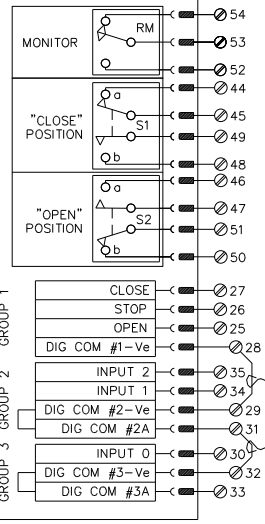
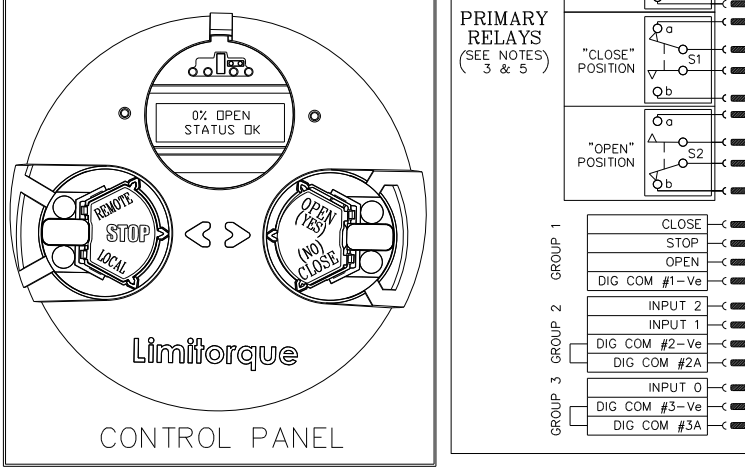
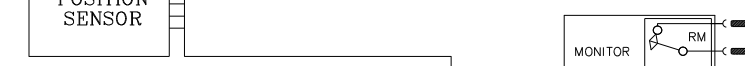
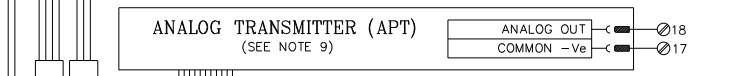

DRAWN	DATE	TITLE
RLP	10/30/12	MXa WIRING DIAGRAM
CHECKED	DATE	UNIT
ZKC	11/01/12	MXa
APPROVED	DATE	DWG NO
ZKC	11/01/12	WD-MXa-000110-0000
		REV
		00H
		SHEET
		1 OF 1

Limitorque Actuation Systems
5114 WOODALL ROAD, LYNCHBURG, VIRGINIA 24506-1318

Modutronic APT (Analog Position Transmitter) Mechanical Contactor OS, (2) 2A, (1) 2A monitor relay 3Wire/4Wire